



General Specifications

MODEL NO.83 900 - 1500LB CAGE GUIDE TYPE CONTROL VALVES

Model 83 control valves have cage guided trim, so that these valves provide wide controllability, wide scope of production for reduced port, and comprehensive applicability for various countmeasures of valve.

These valves permit stable control on valve closing and opening against the thrust of fluid, and are available for applications not only general use but also controlling high temperature and high pressure for power plants and chemical plants. Especially, these valves are suited for low noise application because of the superior noise reduction effect at high load.

Compact design multi-spring type diaphragm actuator is installed on this model and made it available to use for high thrust servies.

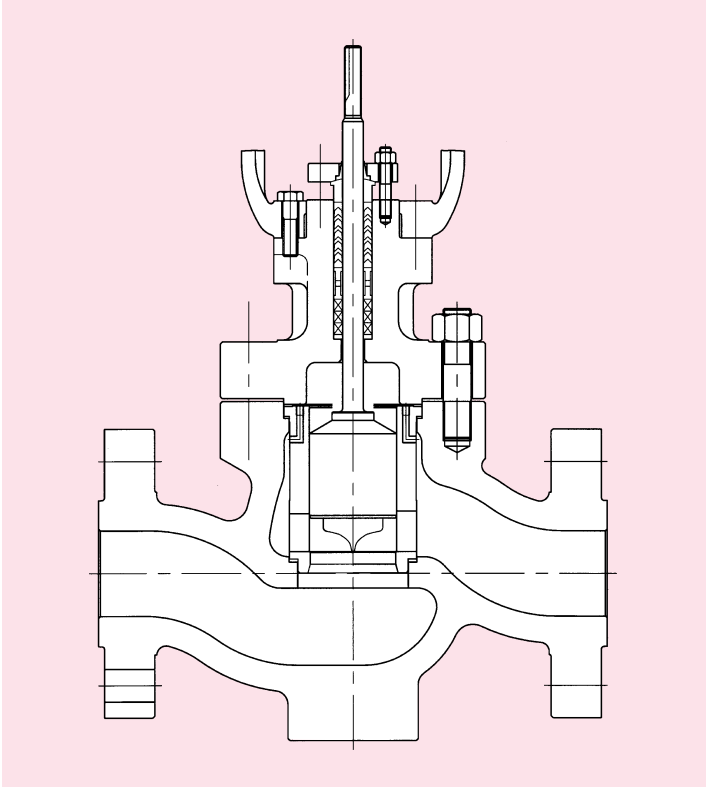

83
900
1500

1. VALVE TYPE

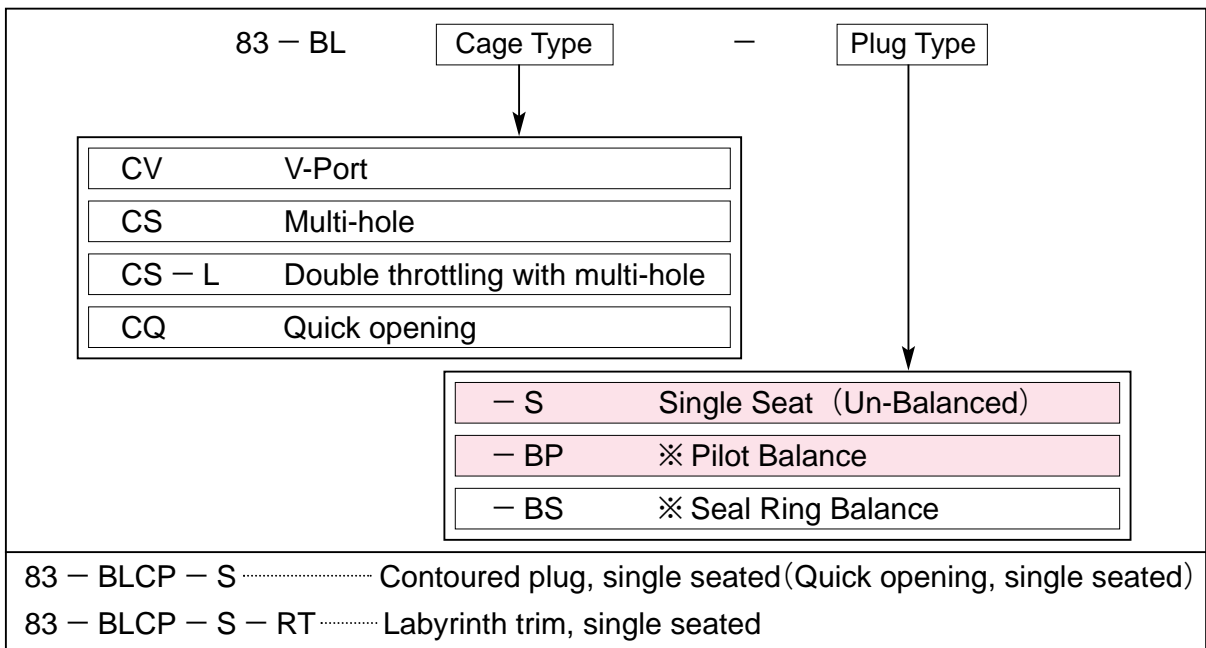

[Note] (1) portion is described in this catalog.
 (2) Full port is our standard type.
 (3) See MCE-B4308 for Type 83-BS.

2. FEATURES

83
900
1500

Model BLCV-S V Port Type

Model BLCV are cage guide type control valves and used for most general purpose with V port of cage characterized.

These valves provide wide applicability, excellent characteristics at high load, and easy maintenance. Moreover, the trim permits soft seat.

Typical Application

- General service
- Power plant and chemical plant
- Medium or high pressure service

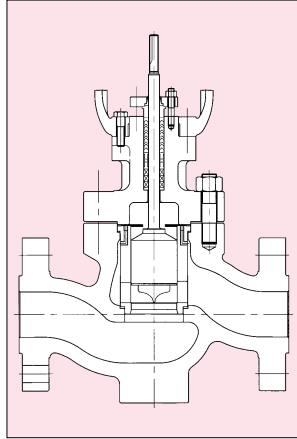

Model BLCV-BP Pilot Balance Type

Model BLCV-BP are cage guide type control valves that valve plug have pilot balance type.

These valves permit low seat leakage ratio such as single seat, and high shut-off thrust in spite of small actuator size as of double seat.

Typical Application

- Turbine bypass valve
- Open valve
- Shut-off valve

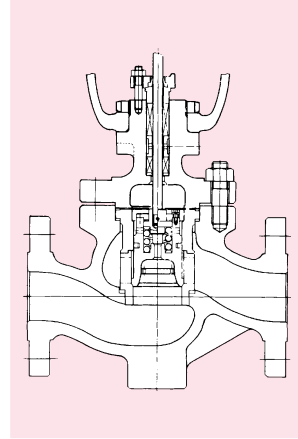

Model BLCS-S Multi-hole Type

Model BLCS permit to reduce the noise for gas service, with Multi-holes in outer cage.

In liquid service which may occur cavitation, CS helps to prevent trim from cavitation damage.

Typical Application

- Low noise valve
- Anti-cavitation valve
- Anti-erosion valve

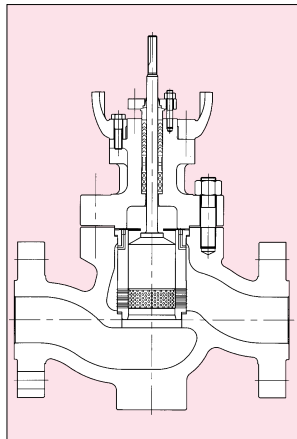

Model BLCP-S Contoured Plug Type Single Seated

Model BLCP-S is cage guide type single seated control valves with contoured plug.

These valves are suited for high temperature and pressure, stand against side vibration, and are available to apply anti-erosion material for trim.

Typical Application

- General use (Small size)
- For high temperature and high differential pressure

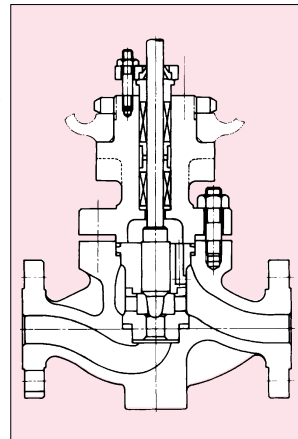

Model BLCS-L-S Double Stage Type with Multi-hole

Model BLCS-L are double throttling type control valve providing additional fixed orifice at downstream side of the Model BLCS.

Because of double throttling mechanism, these valves permit large noise reduction effect.

Typical Application

- Medium and high pressure gas service
- Steam control valve
- Low noise valve

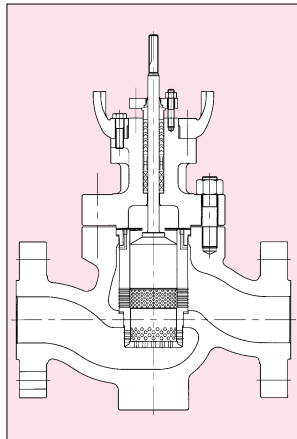

Model BLCP-S-RT Labyrinth Trim Type

Model BLCP-S-RT provide multi-throttling with the trim having labyrinth slots on outer valve plug.

These valves hardly wear the seating surface in spite of low travel service, and are suited for high differential pressure of liquid.

Typical Application

- Boiler feed water small valve
- High differential pressure valve
- Anti-cavitation valve

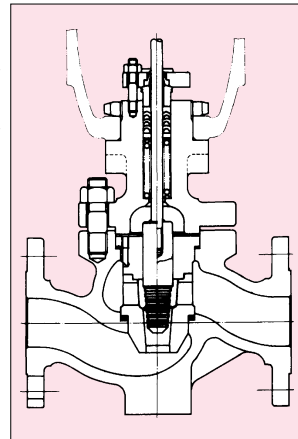

3. SPECIFICATIONS

Valve Type		Diaphragm Operated Cage Guided Control Valve							
Valve Model No.		3883, 2883							
VALVE BODY	Body Type	Model 83-BLCV-S	Model 83-BLCQ-S	Model 83-BLCS-S	Model 83-BLCS-L-S	Model 83-BLCV-BP, BLCQ-BP, BLCS-BP, BLCS-L-BP	Model 83-BLCP-S	Model 83-BLCP-S-RT	
	Valve Sizes mm (in.)	20 ~ 200 (3/4 ~ 8)			25 ~ 200 (1 ~ 8)	50 ~ 200 (2 ~ 8)	20 ~ 40 ⁽⁴⁾ (3/4 ~ 1 1/2)	20 ~ 50 ⁽⁴⁾ (3/4 ~ 2)	
	Pressure Rating	JIS 63K, ANSI Class 900, 1500, JPI 900, 1500 ⁽³⁾							
	End Connections	Flanged end : FF, RF RJ, Male and female, Tongue and groove (※ Welding end : SW, BW)							
	Body Materials	SCPH2, SCPH11, SCPH21, SCPH32, SCPH61, SCS13A, SCS14A							
	Bonnet Types	Plain (− 17 °C to + 230 °C), Fin (− 20 °C to under − 17 °C, over + 230 °C) Extension (Light type : − 100 °C to under − 20 °C, Heavy type : − 196 °C to under − 100 °C)							
	Glnad Type	Bolted gland							
	Packing (Non Asbestos)	GL · PTFE V-ring, Braided packing, Molded packing							
	Gaskets (Non Asbestos)	Serrated gasket, Spiral wound gasket							
	Guiding	Cage guide							
	Valve Plug Action	Push-down close							
	Seat Type	Single seated							
	Cage Shapes	V-Port	Quick opening	Multi-hole	Double stage with multi-hole	Pilot balance		Contoured	Labyrinth trim
	Cage Characteristics	Equal percentage, Linear	Quick opening	Linear, Modified parabolic		Equal percentage, Linear, Modified parabolic, Quick opening		Equal percentage, Linear	Modified parabolic
	Flow Direction FTC FTO 	Single Seated	FTC : Liquid 25kgf/cm ² and over in diff. press. FTO : Except above		FTC : Liquid FTO : Except liquid	FTO (Not available to liquid)		FTC	
	Double Seated	FTC							
Trim Materials	SUS 316, SUS 440B								
Treatment of Trim	See page 5 "Main Materials"								
ACTUATOR	Actuator Type	Model 3800 Multi-spring type single diaphragm operated				Model 2800 Spring type single diaphragm operated			
	Actuator Sizes	N28	N33S	N40	500S	650S	650XS		
	Max.Stroke (mm)	38	38	65	65	65	65		
	Supply Air Press. kPa (kgf/cm²G)	240 (2.4), 280 (2.8), 300 (3.0) 400 (4.0) ... N33S & N40 only				240 (2.4), 280 (2.8)			
	Spring Range kPa (kgf/cm²G)	40 ~ 200 (0.4 ~ 2.0), 80 ~ 200 (0.8 ~ 2.0) 120 ~ 280 (1.2 ~ 2.8) ... N33S & N40 only				20 ~ 180 (0.2 ~ 1.8), 40 ~ 200 (0.4 ~ 2.0), 60 ~ 220 (0.6 ~ 2.2), 80 ~ 240 (0.8 ~ 2.4), 100 ~ 220 (1.0 ~ 2.2)			
	Action	Direct action, Reverse action							
	Materials	(Diaphragm) Cloth reinforced chloroprene rubber, (Yoke) FC 200							
	Air Connection	RC 1/4 RC 3/8 (650S, 650XS)							
Ambient Temperature	− 20 ~ + 70 °C (※ − 50 ~ − 20 °C, + 70 ~ + 100 °C) ⁽²⁾				− 30 ~ + 70 °C (※ − 50 ~ − 30 °C, + 70 ~ + 100 °C) ⁽²⁾				
Painting Color	Silver, No painting on stainless steel								

83
900
1500

VALVE CHARACTERISTICS AND PERFORMANCE (1)	Body Type	Model BLCV-S	Model BLCQ-S	Model BLCS-S	Model BLCS-L-S	Model BLCV-BP, BLCQ-BP BLCS-BP, BLCS-L-BP	Model BLCP-S	Model BLCP-RT		
	Control Mode	Throttling control, On-off control								
	Valve Action	Direct action (Air-to close), Reverse action (Air-to open)								
	Applicable Press. Range	25.3MPa(258kgf/cm ² G) or less (Pressure limit conform to the standard of pressure rating)								
	Applicable Temp. Range	- 196 °C ~ + 550 °C(Temperature limit conform to the standard of pressure rating)								
	Allowable Differential Pressure	See page 8, 9 "Allowabl Shutoff Pressure"								
	Rated Cv Value	See page 6 "Rated Cv Value"								
	Flow Characteristics	See page 7 "Flow Characteristics"								
	Inhelrent Rangeability	50 : 1 (※ 100 : 1) See page 6 "Rated Cv Value"								
	Allowables Seat Leakage Ratio	Single Seated Type				Single Seated Type				
		Metal Seat	V-Port, Multi-hole	0.01 % of rated Cv (ANSI B16.104 Class IV) ※ Tight shut off (TSO) (Valve size) (% of rated Cv) 25mm or less 0.0001 % 100mm or less 0.001 % 125mm or less 0.002 %				0.001 % of rated Cv		0.01 % of rated Cv (ANSI B16.104 Class IV)
				Quick Opening	(Valve size) (% of rated Cv) 25mm or less 0.0001 % 100mm or less 0.001 % 125mm or less 0.002 %		—			
	Action	Hysteresis Error (With positioner)		max. 2 % F.S.						
Accuracy	Linearity (With positioner)		max. ± 2 % F.S.							
ADDITIONAL OPTION ※	Valve Body	Drain plug, Special treatment for trim								
	Actuator	Handwheel (Top-mounted handwheel, Side-mounted handwheel), Travel stop, Oil dash pot (only for Model 2800), Diaphragm material : Ethylene propylene rubber, Yoke material : SCPH2								
	Accessories	Electro-pneumatic positioner (EA91A, EA90A), Pneumatic positioner (PA92A) Air filter regulator (MR 2000), Limit switch, Solenoid valve, Booster relay, Speed controller, Lock up valve, Pneumatic operated valve								
	Others	The High pressure gas safety low Certification, Oil free, Water free, Sandproof, Dustproof, Anti-salt damage. Vacuum service, Cold district spec. Tropical district spec. External exposure bolts & nuts. Specified painting color								

- [Note]** (1) Valve performance is represented under the condition of standard packing (PTFE V-ring).
 (2) ※ Manufactured and attached as option according to customer's order.
 (3) As to valves that the pressure rating is ANSI/JPI Class 600LB or less, please see the catalog, Bulletin No. MCE-B4301.
 (4) On BLCP-S and BLCP-S-RT, Body size 15mm (1/2 inch) is applicable. Specitication is the same as 20mm (3/4 inch).

4. MAIN MATERIALS

1 Typical Combination of Materials

Parts Name	Materials		
Body, Bonnet	SCPH2,11, 21, 32, 61	SUS 13A	SUS 14A
Trim	SUS 316 SUS 440B		SUS 316
Stud Bolt and Nut	SCPH2,11, 21, 32, 61	A 194 GrB8 CL2 / SUS304	

- [Note]** (1) This table shows typical combination of materials. Combination may be changed by service condition such like pressure, tempaure and fluid.
 (2) Casting materials may be used for trim instead of bar materials.

2 Combination of Hard Facing for Trim

Trim Material	SUS316	
Cage Type	BLCV-S、BLCQ-S BLCV-BP、BLCQ-BP BLCP-S、BLCP-S-RT	BLCS-S、BLCS-L-S BLCS-BP、BLCS-L-BP
Guide ⁽¹⁾	Stellite face	
Cage	Stellite seat + Atomloy	
Valve Plug	Stellite face	
Applicable Press. Rang	- 196 °C ~ + 550 °C	
Allowable Differential Pressure	25.3MPa (258kgf/cm ²)	

Trim Material	SUS440B	
Cage Type	BLCV-S、BLCQ-S、BLCS-S BLCP-S、BLCP-S-RT	BLCV-BP、BLCQ-BP BLCS-BP ⁽²⁾
Guide ⁽¹⁾	SUS440B (Heat treatment)	
Cage	SUS440B (Heat treatment)	
Valve Plug	Stellite face	
Applicable Press. Rang	- 20 °C ~ + 400 °C	
Allowable Differential Pressure	25.3MPa (258kgf/cm ²)	

- [Note]** (1) Guide is used for type BP, CP-S and CP-S-RT.
 (2) Valve plug material of SUS440B is not available for model BLCS-L and BLCS-L-BP.
 (3) For flushing, cavitation and saturated steam services, SUS440B trim is suitable in the temperature range - 20 to 400 °C.
 (4) When anti-corrosion body material is required higher than SUS316L, Cage required Stellite facing.

5. SCOPE OF PRODUCTION

1 Combination of Valve Body and Actuator

Valve Size		3883			2883		
mm	inch	N28	N33S	N40	500S	650S	650XS
20	3/4	●	●	●	●		
25	1	●	●	●	●		
40	1 1/2		●	●	●		
50	2		●	●	●	●	
65	2 1/2		●	●	●	●	
80	3			●	●	●	
100	4			●	●	●	
125	5				●	●	●
150	6				●	●	●
200	8					●	●

- [Note]** The body type suffix “- BP” is applied to body size 2 in. and larger.
 The scope of production for body type “BLCP-S” and “BLCP-S-RT” is body size 3/4 to 1 1/2 inch.
 and 3/4 to 2 inch. respectively.

2 Scope of Port (without BLCP-RT type)

Valve Size		Port Size (mm)																
mm	inch	φ 4	6	7	8	10	15	20	25	32	40	50	65	80	100	125	150	200
20	3/4	◆	◆	◆	◆	◆	◆	●										
25	1		◆	◆	◆	◆	◆	◆	●									
40	1 1/2							◆	◆	◆	●							
50	2								◆	◆	◆	●						
65	2 1/2									◆	◆	◆	●					
80	3										◆	◆	◆	●				
100	4											◆	◆	◆	●			
125	5												◆	◆	◆	●		
150	6													◆	◆	◆	●	
200	8														◆	◆	◆	●

[Note] (1) The body type "BLCP-S" is applied to port size 1/2 inch or smaller.
 (2) The body type suffix "- BP" is applied to port size 1 1/4 inch and larger.

3 Scope of Port (BLCP-S-RT type)

Port Size (mm) Valve Size		0.2	0.4	0.6	1.0	1.5	2.0	3.0	5.2	9.0
20mm	3/4 inch	●	●	●	●	●	●			
25	1	●	●	●	●	●	●			
40	1 1/2				●	●	●	●	●	
50	2				●	●	●	●	●	●

6. FLOW CHARACTERISTICS

1 Rated Cv Value

Inherent Rangeability 50 : 1

Port Size(Cv)		mm	20	25	32	40	50	65	80	100	125	150	200
		inch	3/4	1	1 1/4	1 1/2	2	2 1/2	3	4	5	6	8
Rated Teavel(mm)			15		20		25		38		50		65
Rated Cv	BLCV-S (- BP)		7.5	11	16*	24	40	63	93	145	200	320	500
	BLCS-S (- BP)												
	BLCQ-S (- BP)												
	BLCS-L-S (BLCS-L-BP)		-	-	13*	19	32	50	74	116	160	256	400

Port Size		mm	φ 4	6	7	8	10	15		
		inch		1/8	3/16	1/4	3/8	1/2		
Rated Teavel(mm)			15							
Rated Cv	BLCP-S		0.15	0.4	0.8	1.5	3.0	5.2		
Inherent Rangeability			10 : 1		15 : 1		25 : 1		30 : 1	

Rated Cv	BLCP-S-RT	0.2	0.4	0.6	1.0	1.5	2.0	3.0	5.2	9.0
Rated Teavel(mm)		15							20	25
Inherent Rangeability		30 : 1								

[Note] (1) Rated Cv value is the identical value in spite of single seat or doubled seat.
 (2) * Port size for pilot balance type (Model -BP) is more than 32mm (1 1/4 inch).
 (3) Please contact MOTOYAMA's sales office as to over Cv value listed above (wide rang Cv value) on Model BLCP-S.
 (4) Port size for Model BLCP-S-RT represent rated Cv value.

2 Flow Characteristics

■ The flow characteristics of each body type

	Equal %	Linear	Modified Parabolic	On Off
BLCV-S BLCV-BP	●	●		
BLCS-S BLCS-L-S BLCS-BP BLCS-L-BP		●	● ①	
BLCV-S	●	●		
BLCV-S-RT			● ②	
BLCQ-S BLCQ-BP				●

[Note] The meanings of ① and ② are stated on the following [Note].

■ V-Port Type

Equal percentage (Model BLCV, BLCV-BP)

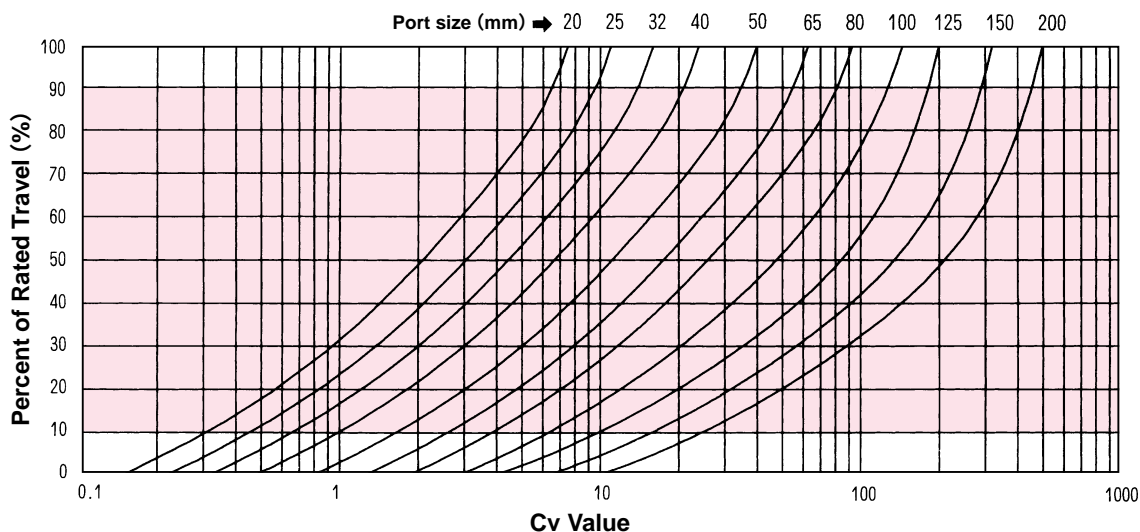

■ Contoured type plug Equal percentage (Model BLCV-S)

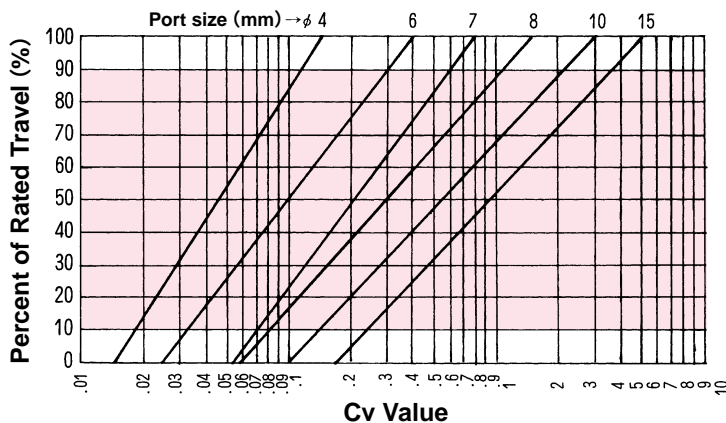

[Note] Shaded zone represents proper throttling control range.

■ Modified Parabolic

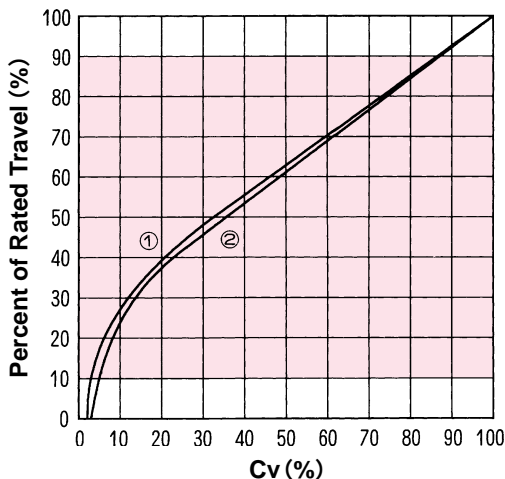

[Note] Curve ① shows for BLCS, BLCS-L and BLCS-BP.
Curve ② shows for BLCV-S-RT.

7. ALLOWABLE DIFFERENTIAL PRESSURE

1 Off-balance Classification

Unit : kPa(kgf/cm²G)

Action			Spring Range		Off-balance	Supply Air Pressure	Positioner	
			Actuator Size					
			N28 ~ N40	500, 650				
Excepting Quick Opening	Direct Action		40 ~ 200(0.4 ~ 2.0)		240(2.4)	40(0.4)	With	
			-		60 ~ 220(0.6 ~ 2.2)	280(2.8)		60(0.6)
			40 ~ 200(0.4 ~ 2.0)		40 ~ 200(0.4 ~ 2.0)	300(3.0)		80(0.8)
			-		20 ~ 180(0.2 ~ 1.8)	280(2.8)		100(1.0)
	※ 120 ~ 280(1.2 ~ 2.8)		-	400(4.0)	120(1.2)			
	Reverse Action		40 ~ 200(0.4 ~ 2.0)		240(2.4)	40(0.4)		
			-		60 ~ 220(0.6 ~ 2.2)	280(2.8)		60(0.6)
			80 ~ 200(0.8 ~ 2.0)		80 ~ 240(0.8 ~ 2.4)	280(2.8)		80(0.8)
-			100 ~ 220(1.0 ~ 2.2)	280(2.8)	100(1.0)			
※ 120 ~ 280(1.2 ~ 2.8)		-	400(4.0)	120(1.2)				
Quick Opening	Direct Action		40 ~ 200(0.4 ~ 2.0)		240(2.4)	40(0.4)	Without	
			-		60 ~ 220(0.6 ~ 2.2)	280(2.8)		60(0.6)
			40 ~ 200(0.4 ~ 2.0)		40 ~ 200(0.4 ~ 2.0)	300(3.0)		80(0.8)
			-		20 ~ 180(0.2 ~ 1.8)	280(2.8)		100(1.0)
	※ 120 ~ 280(1.2 ~ 2.8)		-	400(4.0)	120(1.2)			
	Reverse Action		40 ~ 200(0.4 ~ 2.0)		240(2.4)	40(0.4)		
			-		60 ~ 220(0.6 ~ 2.2)	280(2.8)		60(0.6)
			80 ~ 200(0.8 ~ 2.0)		80 ~ 240(0.8 ~ 2.4)	280(2.8)		80(0.8)
-			100 ~ 220(1.0 ~ 2.2)	280(2.8)	100(1.0)			
※ 120 ~ 280(1.2 ~ 2.8)		-	400(4.0)	120(1.2)				

[Note] ※ Spring range 120 ~ 280kPa is only applicable for Actuator size N33S and N40.

2 Allowable Shut-off Pressure

■ Model BLCV-S, BLCQ-S, BLCS-S, BLCS-L-S

V-Port, Quick Opening, Multi-hole, Double Stage with Multi-hole

Unit : MPa(kgf/cm²)

Port Size		Single Seated Type									
		20mm	25	40	50	65	80	100	125	150	200
Actuator Size	Off-balance	¾ inch	1	1 ½	2	2 ½	3	4	5	6	8
N28	40(0.4)	3.13(32)	2.25(23)								
	80(0.8)	6.27(64)	4.51(46)								
	100(1.0)	7.84(80)	5.68(58)								
N33S	40(0.4)	4.60(47)	3.33(34)	1.47(15)	0.86(8.8)	0.62(6.4)					
	80(0.8)	9.21(94)	6.66(68)	3.04(31)	1.66(17)	1.17(12)					
	100(1.0)	11.5(118)	8.33(85)	3.82(39)	2.15(22)	1.56(16)					
	120(1.2)	13.8(141)	10.1(103)	4.60(47)	2.54(26)	1.86(19)					
N40	40(0.4)	6.47(66)	4.70(48)	2.15(22)	1.17(12)	0.89(9.1)	0.59(6.1)	0.36(3.7)			
	80(0.8)	13.0(133)	9.41(96)	4.31(44)	2.35(24)	1.76(18)	1.17(12)	0.72(7.4)			
	100(1.0)	16.2(166)	11.8(121)	5.39(55)	3.04(31)	2.15(22)	1.47(15)	0.91(9.3)			
	120(1.2)	19.5(199)	14.2(145)	6.47(66)	3.62(37)	2.64(27)	1.76(18)	1.07(11)			
500S	40(0.4)	10.8(111)	7.84(80)	3.62(37)	1.96(20)	1.47(15)	0.98(10)	0.60(6.2)	0.42(4.3)	0.28(2.9)	
	60(0.6)	16.2(166)	11.8(121)	5.39(55)	3.04(31)	2.15(22)	1.47(15)	0.91(9.3)	0.63(6.5)	0.43(4.4)	
	80(0.8)	21.7(222)	15.7(161)	7.25(74)	4.02(41)	2.94(30)	1.96(20)	1.17(12)	0.84(8.6)	0.57(5.9)	
	100(1.0)	25.3(258)	19.7(201)	9.02(92)	5.00(51)	3.72(38)	2.45(25)	1.47(15)	0.98(10)	0.72(7.4)	
650S	40(0.4)				3.43(35)	2.54(26)	1.66(17)	0.98(10)	0.73(7.5)	0.50(5.1)	0.29(3.0)
	60(0.6)				5.19(53)	3.82(39)	2.54(26)	1.56(16)	1.07(11)	0.75(7.7)	0.44(4.5)
	80(0.8)				6.96(71)	5.09(52)	3.43(35)	2.05(21)	1.47(15)	0.98(10)	0.59(6.1)
	100(1.0)				8.72(89)	6.47(66)	4.31(44)	2.64(27)	1.76(18)	1.17(12)	0.74(7.6)
650XS	60(0.6)								2.15(22)	1.47(15)	0.89(9.1)
	80(0.8)								2.94(30)	1.96(20)	1.17(12)
	100(1.0)								3.62(37)	2.45(25)	1.47(15)

Model BLCP-S Contoured Type

Unit : MPa(kgf/cm²)

Port Size		φ4	6mm	7	8	10	15
Actuator Size	Off-balance	—	1/8 inch	3/16	1/4	3/8	1/2
N28	40(0.4)	12.1(124)			10.7(110)	8.04(82)	5.29(54)
	80(0.8)	24.3(248)			21.5(220)	16.0(164)	10.6(109)
	100(1.0)	25.3(258)			25.3(258)	20.2(206)	13.3(136)
N33S	40(0.4)	11.9(122)			11.0(113)	10.1(103)	7.8 (80)
	80(0.8)	24.0(245)			22.1(226)	20.2(206)	15.6(160)
	100(1.0)	25.3(258)				25.2(257)	19.6(200)
	120(1.2)	25.3(258)				25.3(258)	23.5(240)

Model BLCV-BP, BLCQ-BP, BLCS-BP, BLCS-L-BP Pilot Balance Type

The upper row : Allowable shut-off press.
The lower row : Allowable intermediate off.press.

Unit : MPa(kgf/cm²)

Port Size		50 mm	65	80	100	125	150	200
Actuator Size	Off-balance	2 inch	2 1/2	3	4	5	6	8
N33S	40(0.4)	3.23 (33)	2.94 (30)	1.96 (20)	1.17 (12)			
		2.54 (26)		1.86 (19)				
	80(0.8)	7.94 (81)	6.96 (71)	5.00 (51)	3.72 (38)			
		2.54 (26)		1.86 (19)	1.37 (14)			
	100(1.0)	10.2 (105)	9.02 (92)	6.57 (67)	4.90 (50)			
		2.54 (26)		1.86 (19)	1.37 (14)			
	120(1.2)	12.6 (129)	10.9 (112)	8.13 (83)	6.17 (63)			
		2.54 (26)		1.86 (19)	1.37 (14)			
N40	40(0.4)	3.13 (32)	2.74 (28)	2.25 (23)	1.66 (17)	1.07 (11)	0.94(9.6)	
		7.25 (74)	6.37 (65)	5.39 (55)	4.31 (44)	3.33 (34)	2.94 (30)	
	80(0.8)	3.53 (36)		2.64 (27)	1.96 (20)	1.76 (18)	1.37 (14)	
		9.31 (95)	8.23 (84)	6.96 (71)	5.58 (57)	4.51 (46)	3.92 (40)	
	100(1.0)	3.53 (36)		2.64 (27)	1.96 (20)	1.76 (18)	1.37 (14)	
		11.3 (116)	10.1 (103)	8.53 (87)	6.96 (71)	5.58 (57)	4.90 (50)	
	120(1.2)	3.53 (36)		2.64 (27)	1.96 (20)	1.76 (18)	1.37 (14)	
500S	40(0.4)	5.88 (60)	5.19 (53)	4.11 (42)	3.23 (33)	2.35 (24)	2.05 (21)	1.27 (13)
		9.31 (95)	8.23 (84)	6.66 (68)	5.39 (55)	4.31 (44)	3.72 (38)	2.35 (24)
	60(0.6)	5.98 (61)		4.41 (45)	3.33 (34)	3.04 (31)	2.35 (24)	1.76 (18)
		12.7 (130)	11.3 (116)	9.31 (95)	7.55 (77)	6.17 (63)	5.39 (55)	3.53 (36)
	80(0.8)	5.98 (61)		4.41 (45)	3.33 (34)	3.04 (31)	2.35 (24)	1.76 (18)
		16.1 (165)	14.5 (148)	11.8 (121)	9.80 (100)	8.04 (82)	7.06 (72)	4.60 (47)
	100(1.0)	5.98 (61)		4.41 (45)	3.33 (34)	3.04 (31)	2.35 (24)	1.76 (18)
650S	40(0.4)	8.82 (90)	7.84 (80)	6.96 (71)	5.78 (59)	4.70 (48)	4.21 (43)	1.96 (20)
		13.9 (142)	12.5 (128)	10.9 (112)	9.21 (94)	7.74 (79)	6.86 (70)	3.43 (35)
	60(0.6)	10.3 (106)		7.64 (78)	5.88 (60)	5.29 (54)	4.21 (43)	3.04 (31)
		19.0 (194)	17.1 (175)	15.0 (153)	12.6 (129)	10.7 (110)	9.51 (97)	4.80 (49)
	80(0.8)	10.3 (106)		7.64 (78)	5.88 (60)	5.29 (54)	4.21 (43)	3.04 (31)
		24.1 (246)	21.8 (223)	19.0 (194)	16.1 (165)	13.7 (140)	12.2 (125)	6.27 (64)
	100(1.0)	10.3 (106)		7.64 (78)	5.88 (60)	5.29 (54)	4.21 (43)	3.04 (31)
650XS	40(0.4)			10.3 (106)	9.21 (94)	8.04 (82)	7.35 (75)	4.80 (49)
				15.9 (106)	14.1 (144)	12.5 (128)	11.4 (117)	7.64 (78)
	60(0.6)			15.3 (157)	11.7 (120)	10.5 (108)	8.43 (86)	6.17 (63)
				21.4 (219)	19.1 (195)	17.0 (174)	15.5 (159)	10.5 (108)
	80(0.8)			15.3 (157)	11.7 (120)	10.5 (108)	8.43 (86)	6.17 (63)
				27.0 (276)	24.1 (246)	21.5 (220)	19.8 (202)	13.4 (137)
	100(1.0)			15.3 (157)	11.7 (120)	10.5 (108)	8.43 (86)	6.17 (63)

Model BLCV-S-RT Labyrinth Type

Unit : MPa(kgf/cm²)

Actuator Size	Off-balance	Port Size (Rated Cv)								
		0.2	0.4	0.6	1.0	1.5	2.0	3.0	5.2	9.0
N28	40(0.4)	10.1 (103)	7.84 (80)	5.19 (53)						
	80(0.8)	20.2 (207)	15.6 (160)	10.3 (106)						
	100(1.0)	25.3 (258)	19.6 (200)	13.0 (133)						
N33S	40(0.4)	14.9 (152)	11.5 (118)	7.64 (78)			3.62 (37)	0.98 (10)		
	80(0.8)	25.3 (258)	23.1 (236)	15.3 (157)			7.25 (74)	2.05 (21)		
	100(1.0)		25.3 (258)	19.2 (196)			9.12 (93)	2.54 (26)		
	120(1.2)	–			23.0 (235)			10.9 (112)	3.13 (32)	
N40	40(0.4)			7.45 (76)			5.09 (52)	1.47 (15)		
	80(0.8)			14.9 (152)			10.2 (105)	2.94 (30)		
	100(1.0)			18.6 (190)			12.8 (131)	3.62 (37)		
	120(1.2)			22.3 (228)			15.4 (158)	4.41 (45)		
500S	40(0.4)			12.4 (127)			8.62 (88)	2.54 (25)		
	60(0.6)			18.6 (190)			12.9 (132)	3.62 (37)		
	80(0.8)			24.9 (254)			17.2 (176)	4.90 (50)		
	100(1.0)			25.3 (258)			21.5 (220)	6.08 (62)		
650S	40(0.4)			16.1 (165)			14.9 (152)	4.21 (43)		
	60(0.6)			24.3 (248)			22.4 (229)	6.37 (65)		
	80(0.8)								8.53 (87)	
	100(1.0)					25.3 (258)				10.5 (108)

- [Note] (1) portion shows standard combination of valve Body and Actuator.
 (2) Shut-off pressure of this table shows the value only with standard gland packing. (PTFE V-ring)
 (3) When tight shut off (TSO) is required on type BLCV-S, BLCS-S, BLCS-L-S and BLCQ-S, allowable Shut-off pressure shall be multiplied by 1/1.2 from the table above.
 (4) On type BLCV-S, BLCS-S and BLCS-L-S, when the valve is used for flow-to-close (FTC) action, it is required to check the intermediate differential pressure.
 (5) Allowable shut-off pressure for each pilot-balance type valves is selected from the valve size.
 (6) Off-balance 100kPa (1.0kgf/cm²G) is not applicable for reverse action, actuator size 500S rated travel 65mm. Actuator size 500L should be selected.
 (7) Off-balance 120kPa (1.2kgf/cm²G) on actuator size N33S and N40 is only applicable for type BLCQ-S. It is not applicable for type BLCV-S, BLCS-S and BLCS-L-S.
 (8) Actuator size N28 is not applicable for "Oil free" services. Minimum actuator size is N33S.

8. MAIN DIMENSIONS AND WEIGHTS

1 Face-to-face Dimensions of Valve

Unit : mm

Valve Size		JIS 63K RF	ANSI · JPI 900RF	ANSI · JPI 1500RF	ANSI · JPI 900RJ	ANSI · JPI 1500RJ	(900,1500LB) SW, BW
(mm)	(inch)						
20	3/4	250	260				350
25	1		265				
40	1 1/2	295	305				390
50	2	345	367	370			
65	2 1/2	400	417	420		460	
80	3	445	457	472	460	475	530
100	4	515	532	547	535	550	600
125	5	575	587	632	590	635	730
150	6	635	652	704	655	710	900
200	8	700	717	835	720	845	1100

2 Masses

Following table shows standard mass for valve body assembly completed with actuator except accessories. As to the weights not represented in this table, please contact your nearest MOTOYAMA's sales office.

Unit : kg

Valve Size Act. Size	(mm)	20	25	40	50	65	80	100	125	150	200
	(inch)	3/4	1	1 1/2	2	2 1/2	3	4	5	6	8
N28		53	57	74	107	138	–	–	–	–	–
N33S		62	66	83	116	147	210	290	–	–	–
N40		93	97	110	150	180	235	315	460	540	–
500SD		130	135	150	185	220	270	350	495	575	850
500SR		145	150	165	200	235	285	365	510	590	865
650SD		–	–	–	370	405	455	535	675	760	970
650SR		–	–	–	395	430	480	560	700	785	995
650XSD		–	–	–	–	–	–	–	775	855	1065
650XSR		–	–	–	–	–	–	–	805	885	1095

- [Note] (1) This table is applicable for the valves with standard plain bonnet.
 (2) For actuator size N28 to N40, the mass either direct and reverse action are the same.

3 Standard Dimensions

Unit : mm

Valve Size		Actuator Size	D	E	Plain Bonnet		Fin Bonnet		Extension-L		C _R	S	Remarks		
mm	inch				G	C	G	C	G	C					
20	3/4	N28	280	75	200	536	277	613	438	774	-	220			
		N33S	330			591		668		829		240			
		N40	400		752	805	1073	350							
		500S	500		971	1024	1292	160	370						
25	1	N28	280	75	200	536	277	613	438	774	-	220			
		N33S	330			591		668		829		240			
		N40	400		752	805	1073	350							
		500S	500		971	1024	1292	160	370						
40	1 1/2	N33S	330	95	198	589	276	667	444	835	-	240			
		N40	400		750	814	568	1083	350						
		500S	500		969	1033	1302	160	370						
50	2	N33S	330	120	234	625	312	703	573	964	-	240			
		N40	400			786		850		1244		350			
		500S	500		1005	1069	1463	160	370						
		650S	650		1301	1369	1759	250	380						
65	2 1/2	N33S	330	140	243	634	321	712	584	975	-	240			
		N40	400			795		859		1255		350			
		500S	500		1014	1078	1474	160	370						
		650S	650		1310	1378	1770	250	380						
80	3	N33S	330	144	284	675	354	745	610	1001	-	240			
		N40	400			826		896		1328		350			
		500S	500		1045	1115	1547	160	370						
		650S	650		1341	1415	1843	250	380						
100	4	N33S	330	180	334	725	404	795	660	1051	-	240			
		N40	400			876		946		1378		350			
		500S	500		1095	1165	1597	160	370						
		650S	650		1391	1465	1893	250	380						
125	5	N40	400	195	379	894	470	985	893	1408	-	350			
		500S	500					1113		1204		1627		160	370
		650S	650					1409		1500		1923		250	380
		650XS	650					1888		1979		2402		300	410
150	6	N40	400	220	414	929	505	1020	930	1445	-	350			
		500S	500					1148		1239		1664		160	370
		650S	650					1444		1535		1960		250	380
		650XS	650					1923		2014		2439		300	410
200	8	500S	500	260	469	1203	577	1311	1006	1740	-	370			
		650S	650					1499		1607		2036		250	380
		650XS	650					1978		2086		2515		300	410

[Note] (1) Dimension C represents in case of direct action. The dimension C of actuator size N24-N40 for reverse action is to be added 25mm to the numerical value of above table.
 (2) The total valve height with reverse acting actuator size 500S and 650S and 650XS is to be added dimension C and C_R.
 (3) Dimension S shows required space for dismantling Actuator.

Plain Bonnet, Fin Bonnet

Actuator Size **N24 ~ N40**

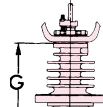
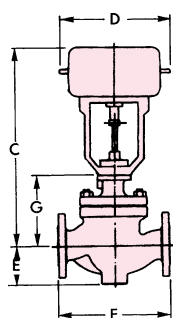

Actuator Size **500 ~ 650XS**

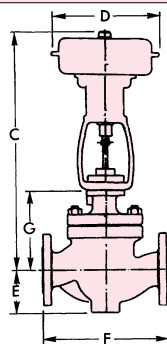

Extension Bonnet (- L)

Actuator Size **N24 ~ N40**

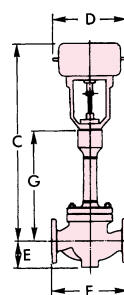

Actuator Size **500 ~ 650XS**

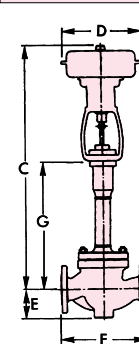

9. MOUNTING ORIENTATIONS

Standard mounting orientations are as follows.

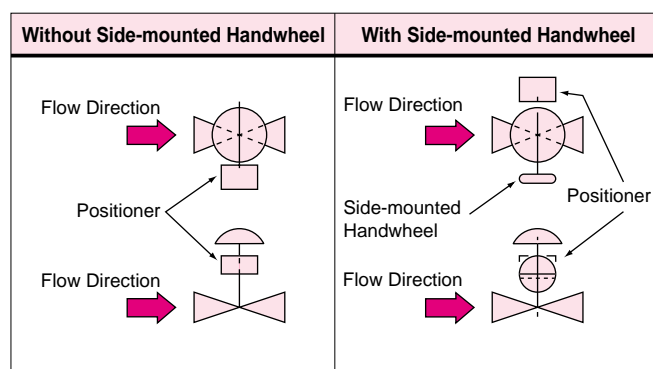



株式会社 **本山製作所**

MOTOYAMA ENG. WORKS, LTD.

http://www.motoyama-cp.co.jp

本 社 工 場 〒981-3697 宮城県黒川郡大衡村大衡字亀岡5-2 TEL(022)344-4511(代表) / FAX(022)344-4522
E-mail : info@motoyama-cp.co.jp

Main Office & Factory 5-2, Ohira Aza Kameoka, Ohira-mura, Kurokawa-gun, Miyagi, 981-3697, Japan
TEL +81-22-344-4511 / FAX +81-22-344-4522
E-mail : info-overseas@motoyama-cp.co.jp

●販売・サービスネットワーク

東 京 支 店	〒210-0007 神奈川県川崎市川崎区駅前本町 10-5 クリエ川崎 11F	TEL (044) 381-8770 (代表)	FAX (044) 381-8772
大 阪 支 店	〒550-0014 大阪市西区北堀江 1 丁目 12-19 クリモビル 3F	TEL (06) 6535-8111 (代表)	FAX (06) 6535-8655
国 際 営 業 部	〒210-0007 神奈川県川崎市川崎区駅前本町 10-5 クリエ川崎 11F	TEL (044) 381-8771	FAX (044) 381-8773
札 幌 営 業 所	〒001-0912 札幌市北区新琴似 12 条 7 丁目 1-47 リパティタウンP棟 101号	TEL (011) 766-1520	FAX (011) 766-1521
東 北 営 業 所 大 衡 サービスセンター	〒981-3697 宮城県黒川郡大衡村大衡字亀岡 5-2	TEL (022) 344-1761	FAX (022) 344-1762
上 越 営 業 所 上 越 サービスセンター	〒942-0036 新潟県上越市大字東中島 2393 番地	TEL (025) 542-5151	FAX (025) 542-5152
関 東 営 業 所 千 葉 サービスセンター	〒290-0046 千葉県市原市岩崎西 1 丁目 5-19	TEL (0436) 21-4400	FAX (0436) 21-3540
静 岡 営 業 所	〒422-8033 静岡県駿河区登呂 4 丁目 28-5	TEL (054) 269-5377	FAX (054) 237-5855
名 古 屋 営 業 所 中 部 サービスセンター	〒481-0012 愛知県北名古屋市久地野安田 36 番地	TEL (0568) 26-6681	FAX (0568) 26-6631
水 島 営 業 所	〒710-0042 岡山県倉敷市二日市 358	TEL (086) 486-3381	FAX (086) 486-3382
阪 神 サービスセンター	〒560-0894 大阪府豊中市勝部 2 丁目 18-3	TEL (06) 6854-7511	FAX (06) 6854-7512
姫 路 出 張 所	〒672-8014 兵庫県姫路市東山 276 番地 1	TEL (079) 263-8640	FAX (079) 246-2130
徳 山 営 業 所 周 南 サービスセンター	〒745-0861 山口県周南市新地 1 丁目 6-11	TEL (0834) 21-5012	FAX (0834) 31-0450
四 国 営 業 所 新 居 浜 サービスセンター	〒792-0896 愛媛県新居浜市阿島 1 丁目 6-26	TEL (0897) 47-8993	FAX (0897) 47-8995
大 分 営 業 所 大 分 サービスセンター	〒870-0141 大分県大分市三川新町 1 丁目 3-23	TEL (097) 576-7032	FAX (097) 576-7033

●海外関連会社

本山 閩門 (大連) 有限公司 〒116601 中国 遼寧省大連市金州新区港興大街 39 号 14-7 TEL +86-411-6589-1277 FAX +86-411-6589-1278

●海外販売代理店

中国、韓国、台湾、シンガポール、インドネシア、マレーシア、サウジアラビア

●SALES AND SUPPORT NETWORK

Overseas Marketing & Sales Dept. : 11th Floor, Clie Kawasaki, 10-5, Ekimae-honcho, Kawasaki-ku, Kawasaki-city, Kanagawa, 210-0007 Japan
TEL: +81-44-381-8771 FAX : +81-44-381-8773

Domestic Sales Branches : Tokyo, Osaka, Sapporo, Tohoku, Joetsu, Kanto, Shizuoka, Nagoya, Hanshin, Tokuyama, Shikoku, Oita

●OVERSEAS AFFILIATED COMPANY

MOTOYAMA VALVE (DALIAN) CO., LTD
Gangxing Street 39-14-7, Jinzhou New District, Dalian-city, 116601 China TEL: +86-411-6589-1277 FAX: +86-411-6589-1278

●OVERSEAS NETWORK

China, Korea, Taiwan, Singapore, Indonesia, Malaysia, Saudi Arabia

◆当社は保証期間を原則として製品納入後 1 年としています。

◆The product will be warranted for one year after delivering this product in principle.

■本カタログの記載内容は、商品の改良等のため予告なく変更することがありますので予めご了承下さい。

■MOTOYAMA is continuously improving and upgrading its product design, specifications and/or dimensions. Information included herein is subject to change without notice.

■本カタログは正しい情報の提供を目的としたものであり、本製品の市場性または適合性の保証を証明するものではありません。

■This catalog is supplied for information purpose only and should not be considered certified marketability and conformability of this product.